

## Description

The SPCL6 series of high power TVS diode is specially designed for meeting severe surge test environment of both AC and DC line protection applications. It features a very fast response and ultra low clamping characteristics over traditional metal oxide varistor ( MOV ) solutions. They can be connected in series and / or parallel to create a very high surge current protection solution.

## Applications

- Communication Equipment
- Security & Protection
- Industrial Control Equipment
- Power Supply
- Automotive Electronics
- New Energy
- Lightning Protection

## Features

- Very low clamping voltage
- Sharp breakdown voltage
- Low slope resistance
- Bi-directional
- Snapback technology for superior clamping factor
- Symmetric in leads width for easier soldering during assembly
- IEC-61000-4-2 ESD 30 kV ( Air ), 30 kV ( Contact )
- ESD protection of data lines in accordance with IEC 61000-4-2
- EFT protection of data lines in accordance with IEC 61000-4-4
- Surge protection of lightning in accordance with IEC61000-4-5
- Halogen-free
- RoHS compliant
- Glass passivated junction
- Pb-free E4 means 2nd level interconnect is Pb-free and the terminal finish material is Silver

## Functional Diagram



Bi-Directional

## Package Outline Dimensions

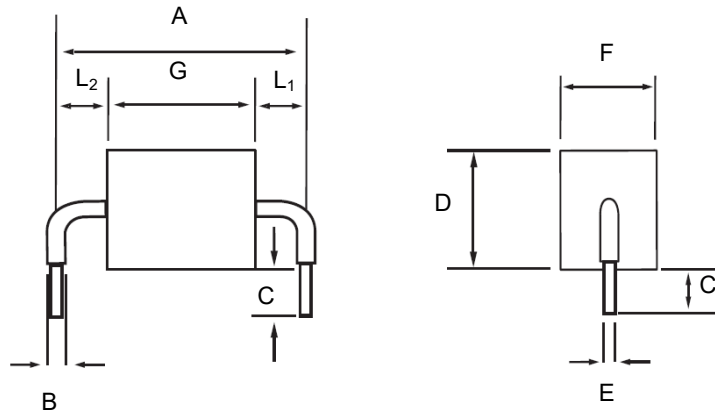

Symbol	Millimeters	Inches
A	24.15 ± 1.00	0.951 ± 0.040
B	2.50 ± 0.70	0.100 ± 0.028
C	6.00 ± 1.00	0.236 ± 0.040
D	14.48 max.	0.570 max.
E	1.28 ± 0.05	0.051 ± 0.002
F	12.70 max.	0.500 max.
G - 015C	3.00 ± 1.00	0.119 ± 0.040
G - 030C / -038C	4.10 ± 1.00	0.161 ± 0.040
G - 058C / -066C / -076C	4.80 ± 1.00	0.189 ± 0.040
G - 170C / 190C	8.13 ± 1.00	0.320 ± 0.040
G - 240C	9.40 ± 1.00	0.370 ± 0.040
G - 380C-Y / 430C	13.80 ± 1.00	0.543 ± 0.040
L <sub>1</sub> / L <sub>2</sub>	L <sub>1</sub> = L <sub>2</sub> Tolerance ± 1.0 mm ( ± 0.04 inch )	

## Part Numbering System

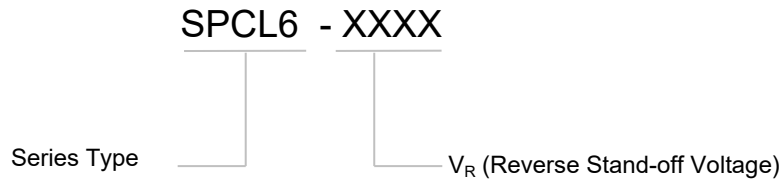

## Marking

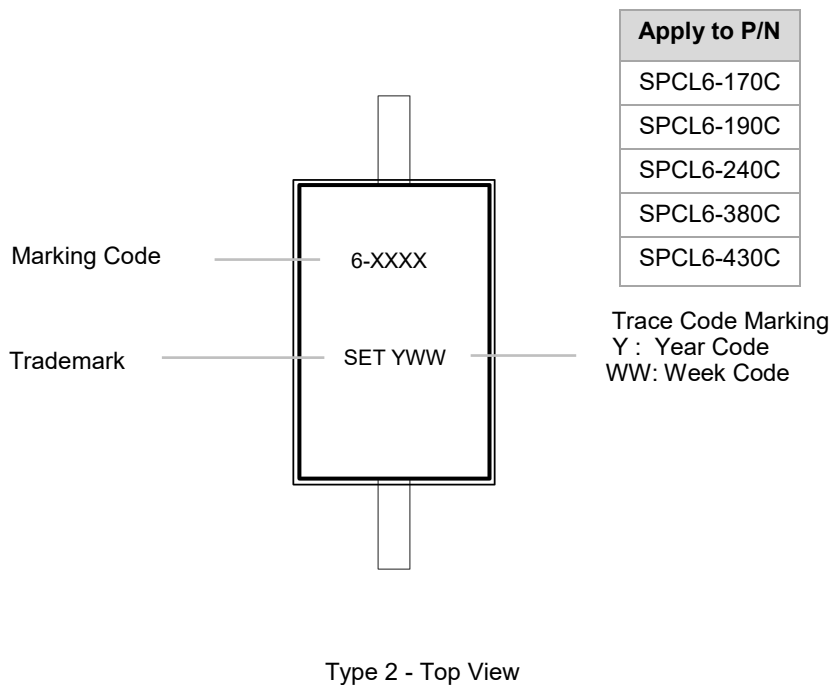
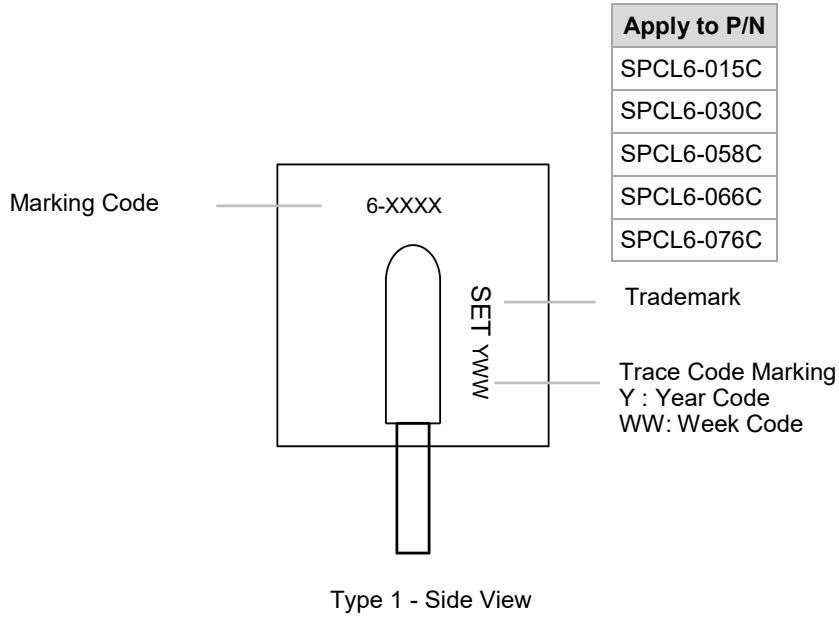

### Electrical Characteristics ( $T_A = 25\text{ }^\circ\text{C}$ unless otherwise noted )

Part Number	Device Marking Code	Breakdown Voltage $V_{BR@I_T}$		Test Current $I_T$	Stand-off Voltage $V_R$	Max. Reverse Leakage $I_R@V_R$	Typical $I_R@85^\circ\text{C}$	Max. Clamping Voltage $V_{CL}$ @ $I_{PP}$ Peak Pulse Current ( $I_{PP}$ ) (Note 1)		Max. Temp Coefficient OF $V_{BR}$	Typ. Capacitance 0 Bias 10kHz
		Min	Max					$I_{PP}(A)$	$V_{CL}(V)$		
		(V)									
SPCL6-015C	6-015C	16.0	19.0	10	15	10	15	6000	28	0.1	28.0
SPCL6-030C	6-030C	32.0	37.0	10	30	10	15	6000	58	0.1	11.0
SPCL6-038C	6-038C	42.6	47.6	10	38	10	15	6000	73.4	0.1	11.0
SPCL6-058C	6-058C	64.0	70.0	10	58	10	15	6000	110	0.1	8.0
SPCL6-066C	6-066C	72.0	80.0	10	66	10	15	6000	120	0.1	6.0
SPCL6-076C	6-076C	85.0	95.0	10	76	10	15	6000	140	0.1	6.5
SPCL6-170C	6-170C	180.0	220.0	10	170	10	15	6000	260	0.1	2.8
SPCL6-190C	6-190C	200.0	245.0	10	190	10	15	6000	290	0.1	2.5
SPCL6-240C	6-240C	250.0	285.0	10	240	10	15	6000	340	0.1	2.0
SPCL6-380C	6-380C	401.0	443.0	10	380	10	15	6000	520	0.1	1.4
SPCL6-430C	6-430C	440.0	490.0	10	430	10	15	6000	625	0.1	1.0

Note:

- Using 8 / 20  $\mu s$  wave shape as defined in IEC 61000 -4-5.

### Maximum Ratings and Characteristics

(  $T_A = 25\text{ }^\circ\text{C}$  unless otherwise specified. )

Parameter	Symbol	Value	Unit
Operating Storage Temperature Range	$T_{STG}$	-55 to 150	$^\circ\text{C}$
Operating Junction Temperature Range	$T_J$	-55 to 125	$^\circ\text{C}$
Current Rating (Note 1)	$I_{PP}$	6	kA

Note:

Rated  $I_{PP}$  measured with 8/20  $\mu s$  pulse.

## Ratings and Characteristic Curves ( $T_A = 25^\circ\text{C}$ unless otherwise noted)

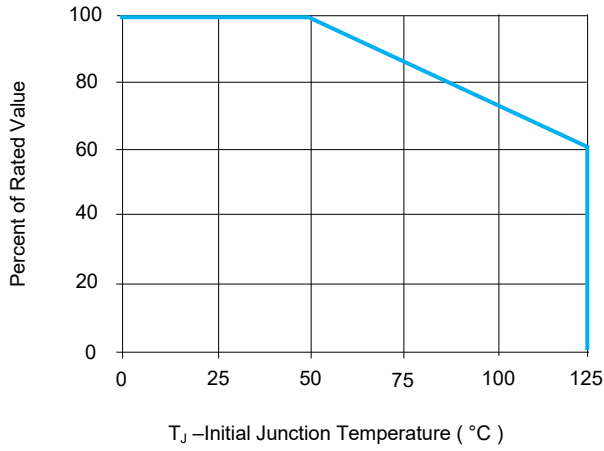

FIGURE 1 Peak Pulse Power Derating Curve

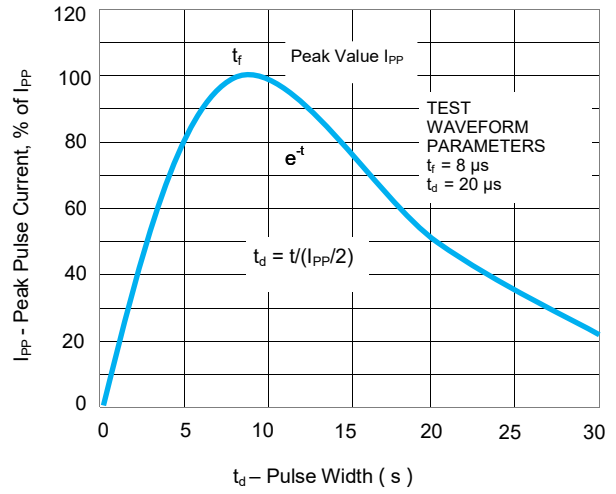

FIGURE 2 Pulse Waveform

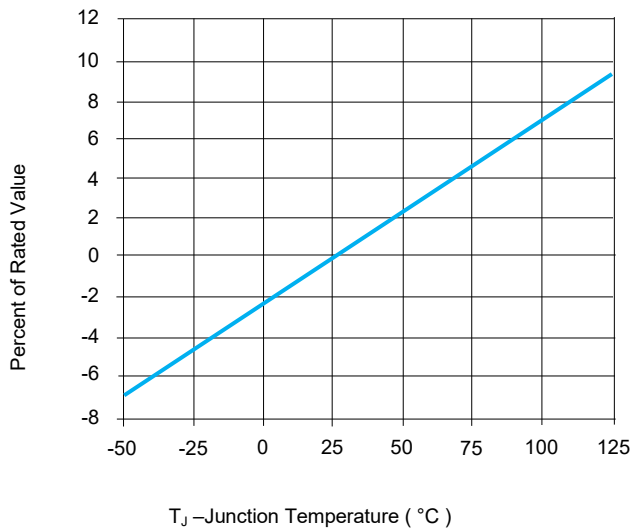

FIGURE 3 Typical  $V_{BR}$  Vs Junction Temperature

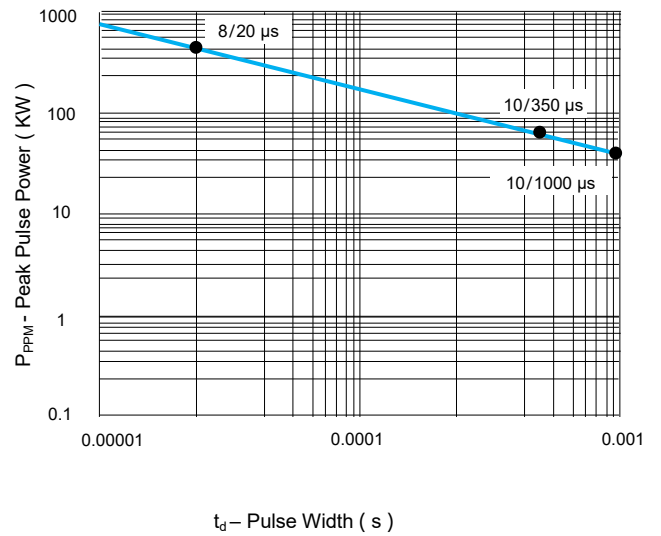
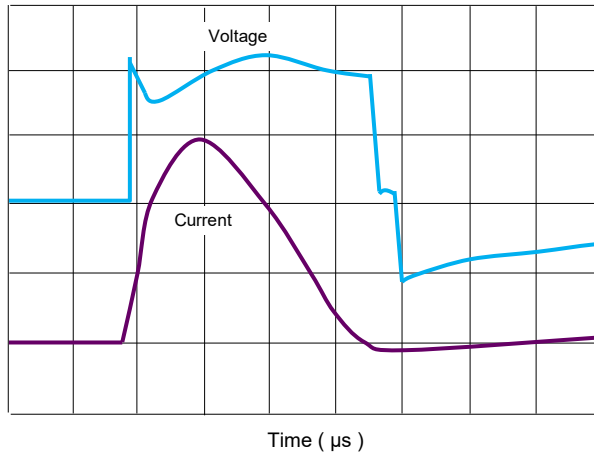

FIGURE 4 Peak Pulse Power Rating Curve



**Note:** The power dissipation causes a change in avalanche voltage during the surge and the avalanche voltage eventually returns to the original value when the transient has passed.

FIGURE 5 Surge Response ( 8/20 Surge current waveform )

## Flow/Wave Soldering (Solder Dipping)

## Physical Specifications

<b>Peak Temperature</b>	260 °C +0 / -5 °C	<b>Weight</b>	Contact manufacturer
<b>Dipping Time</b>	10 seconds	<b>Case</b>	Epoxy encapsulated
<b>Soldering Number</b>	1 time	<b>Terminal</b>	Silver plated leads, solderable per MIL-STD-750 Method 2026

## Soldering Parameters

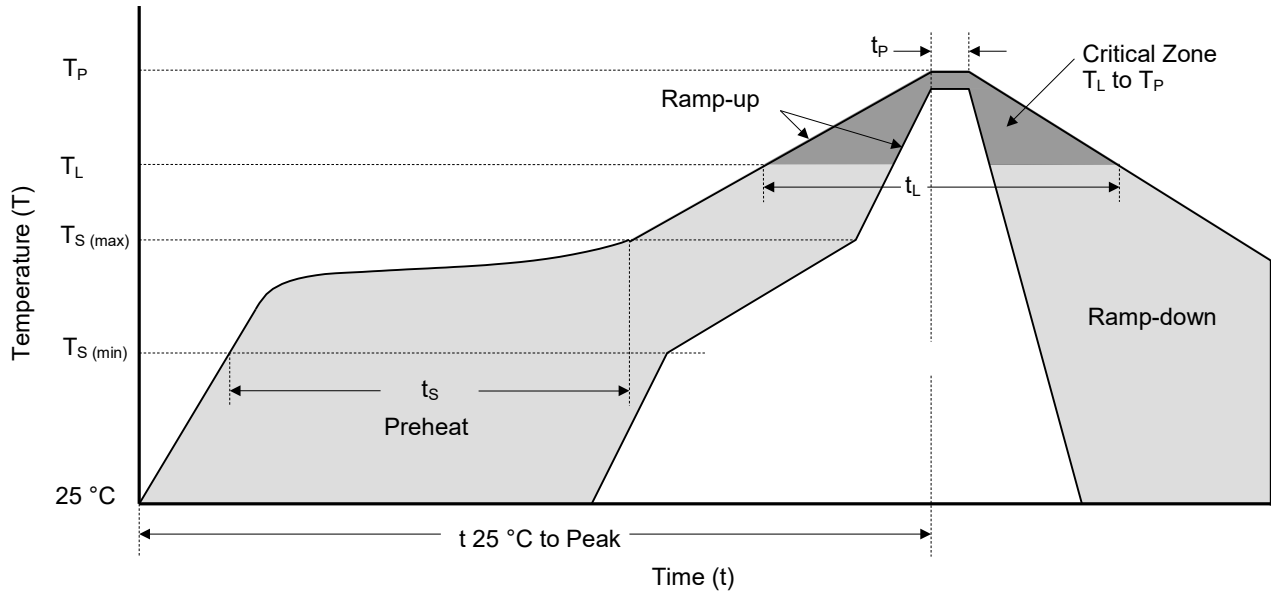

Reflowing Condition

Reflow Soldering Parameters		Lead-Free Assembly
Pre-heat	Temperature Min ( $T_{S(min)}$ )	150 °C
	Temperature Max ( $T_{S(max)}$ )	200 °C
	Time (min to max) ( $t_s$ )	60 ~ 120 seconds
Average Ramp Up Rate (Liquidus Temp ( $T_L$ ) to Peak)		3 °C / second max.
$T_{S(max)}$ to $T_L$ Ramp-up Rate		3 °C / second max.
Reflow	Temperature ( $T_L$ ) (Liquidus)	217 °C
	Time (min to max) ( $t_L$ )	60 ~ 150 seconds
Peak Temperature ( $T_P$ )		260 <sup>+0/-5</sup> °C
Time of within 5 °C of Actual Peak Temperature ( $t_p$ )		20 ~ 40 seconds
Ramp-down Rate		6 °C / second max.
Time from 25 °C to Peak Temperature		8 Minutes max.
Do Not Exceed		260 °C

## Packaging Information

Part Number	Package	Quantity	Packaging Option
SPCL6-XXXX	SPCL Package	56 PCS / Inner Box	Bulk
SPCL6-XXXX-12	SPCL Package	12 PCS / Inner Box	Bulk

## Glossary

Item	Description
$V_C$	<b>Clamping Voltage</b> Voltage across TVS in a region of low differential resistance that serves to limit the voltage across the device terminals.
$V_R$	<b>Reverse Stand-off Voltage</b> Maximum voltage that can be applied to the TVS without operation. NOTE : It is also shown as $V_{WM}$ (maximum working voltage (maximum d.c. voltage)) and known as rated stand-off voltage ( $V_{so}$ ).
$I_R$	<b>Reverse Leakage Current</b> Current measured at $V_R$ . NOTE : Also shown as $I_D$ for stand-by current.
$V_{BR}$	<b>Breakdown Voltage</b> Voltage across TVS at a specified current $I_T$ in the breakdown region.
$I_{PPM}$	<b>Rated Random Recurring Peak Impulse Current</b> Maximum-rated value of random recurring peak impulse current that may be applied to a device.
$P_{M(AV)}$	<b>Rated Average Power Dissipation</b> Maximum-rated value of power dissipation resulting from all sources, including transients and standby current, averaged over a short period of time.
$P_{PPM}$	<b>Rated Random Recurring Peak Impulse Power Dissipation</b> Maximum-rated value of the product of rated random recurring peak impulse current ( $I_{PPM}$ ) multiplies by specified maximum clamping voltage ( $V_C$ ).
$C_J$	<b>Capacitance</b> Capacitance across the TVS measured at a specified frequency and voltage.
$V_{FS}$	<b>Peak Forward Surge Voltage</b> Peak voltage across an TVS for a specified forward surge current ( $I_{FS}$ ) and time duration. NOTE : Also shown as $V_F$ .
$I_{FS}$	<b>Forward Surge Current</b> Pulsed current through TVS in the forward conducting region. NOTE : Also shown as $I_F$ .
$\alpha_{V(BR)}$	<b>Temperature Coefficient of Breakdown Voltage</b> The change of breakdown voltage divided by the change of temperature.
$I_{PP}$	<b>Peak pulse Current</b> Peak pulse current value applied across the TVS to determine the clamping voltage $V_C$ for a specified wave shape.
$I_T$	<b>Pulsed D.C. Test Current</b> Test current for measurement of the breakdown voltage $V_{BR}$ . This is defined by the manufacturer and usually given in milliamperes with a pulse duration of less than 40 ms. NOTE : Also shown as $I_{BR}$ .

—(GB-T 18802.321 / IEC 61643-321 / JESD210A)





## ATTENTION

### Usage

1. TVS must be operated in the specified ambient temp.
2. Do not clean the TVS with strong polar solvent such as ketone, esters, benzene and halogenated hydrocarbon, to avoid damaging the encapsulating layer.
3. Please do not apply severe vibration, shock or pressure to TVS, to avoid element cracking.

### Replacement

1. If TVS is visually damaged, please replace it.
2. TVS is a non-repairable product. For safety sake, please use equivalent TVS for replacement.

### Storage

1. Storage Temp. Range: (-55 to 150) °C.
2. Do not store the TVS at the high temp., high humidity or corrosive gas environment, to avoid influencing the solder-ability of the lead wires. The product shall be used up within 1 year after receiving the goods.

### Environmental Conditions

1. TVS should not be exposed to the open air, nor direct sunshine.
2. TVS should avoid rain, water vapor or other condition of high temp. and high humidity.
3. TVS should avoid sand dust, salt mist, or other harmful gases.

### Max. Typical Capacitance of TVS

The typical capacitance of TVS is listed in the specifications. Designers may refer to it when designing TVS in High frequency circuit.

### Installation Mechanical Stress

1. Do not knock TVS when installing, to avoid mechanical damage.
2. Please do not apply severe vibration, shock or pressure to TVS, to avoid surface resin or element cracking.





## Transient Voltage Suppressor ( Surface Mount ) Features Overview

Package Type	Series								Page	
	DO-221AC	DO-214AA	DO-214AB	DO-214AC	SOD-123FL	SMT0-218	SMA6L	SACB	SMBJ	P6SMB
Product Outline (mm)										
$V_R / V_{WM}$ (V) Reverse Stand-off Voltage	5.0 ~ 250	5.0 ~ 85	5.0 ~ 440	5.8 ~ 468		5.0 ~ 250		5.0 ~ 50	5.0 ~ 440	5.8 ~ 512
$P_{PPM}$ (W) (10/1000 $\mu$ s) Rated Peak ImPulse Power Dissipation	200		400			600		500		600
$I_{PPM}$ (kA)(8/20 $\mu$ s) Rated Peak ImPulse Current							○			
Operating Temperature (°C)							-55 to +150			

**Transient Voltage Suppressor ( Surface Mount ) Features Overview**

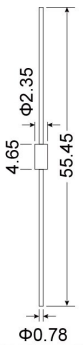
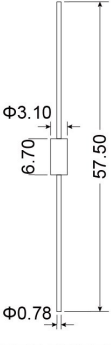
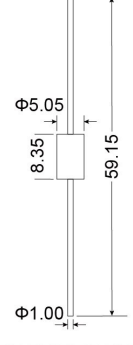
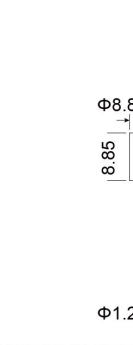
Package Type	Series									
	SMCJ	1.5SMC	3.0SMCJ	SMDJ	5.0SMDJ	SPC1	SPC3	SPC6	SPC10	Page
DO-221AC	○	○	○	○	○	○	○	○	○	
DO-214AA	○	○	○	○	○	○	○	○	○	
DO-214AB	○	○	○	○	○	○	○	○	○	
DO-214AC	○	○	○	○	○	○	○	○	○	
SOD-123FL	○	○	○	○	○	○	○	○	○	
SMT0-218	○	○	○	○	○	○	○	○	○	
Product Outline (mm)										
$V_R / V_{WM}$ (V) Reverse Stand-off Voltage	5.0 ~ 440	5.8 ~ 512	5.0 ~ 440	12 ~ 170	380 / 430	66	58 ~ 76	58 ~ 86		
$P_{PPM}$ (W) (10/1000 $\mu$ s) Rated Peak ImPulse Power Dissipation	1500		3000	5000			○			
$I_{PPM}$ (kA)(8/20 $\mu$ s) Rated Peak ImPulse Current			○		1	3	6	10		
Operating Temperature (°C)			-55 to +150				-55 to +125			

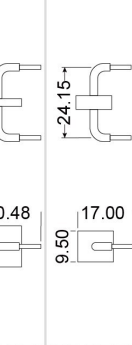
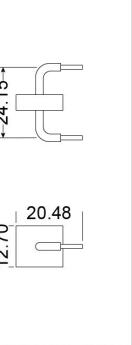
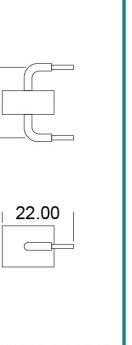
## Transient Voltage Suppressor ( Axial Lead ) Features Overview

Package Type	Series														Page		
	DO-201	DO-41	DO-15	P600	Radial lead	1.5KE	LCE	5KP	15KPA	20KPA	30KPA	SPCL1	SPCL3	SPCL6		SPCL10	SPCL15
Product Outline (mm)																	
$V_R / V_{WM}$ (V) Reverse Stand-off Voltage	5.8 ~ 468	5.0 ~ 50	5.8 ~ 512	5.8 ~ 512	6.5 ~ 90	5.0 ~ 250	17 ~ 280	20 ~ 300	28 ~ 360	76	15 ~ 430	30 ~ 430	15 ~ 530	58 ~ 380	16 ~ 76		
$P_{PPM}$ (W) (10/1000 $\mu$ s) Rated Peak ImPulse Power Dissipation	400	500	600	1500	5000	15000	20000	30000									
$I_{PPM}$ (kA)(8/20 $\mu$ s) Rated Peak ImPulse Current												1	3	6	10	15	20
Operating Temperature (°C)					-55 to +150												-55 to +125